

TCD 2011

For mobile machinery

23 - 74.9 kW | 31 - 100 hp at 1600 - 2800 min⁻¹ | rpm

EU Stage IIIA / US EPA Tier 3

- 2, 3 and 4-cylinder engines and 4-cylinder engines with inline turbocharging, oil-cooled or optionally with an integrated cooling system. The 4-cylinder engine is also available with water cooling and charge air cooling.
- The compact engine design and an optional PTO drive reduce the installation costs and increase the number of applications.
- Best cold starting properties even under extreme conditions.



- The engines in the power range < 56 kW meet to the US EPA Tier 4 i.

- The robust engine design allows worldwide operation even with high sulphur fuels.
- All parts for maintenance on one side of the engine, long oil change intervals and easy changing of engine fluids reduce the running costs and increase the availability of the machinery.
- An efficient injection system and optimized combustion ensure optimum engine performance at low consumption.

Technical data

air/oil-cooled with integrated cooling system

Engine type		D 2011 L2 I	D 2011 L3 I	D 2011 L4 I	TD 2011 L4 I
No. of cylinders		2	3	4	4
Bore/stroke	mm in	94/112 3.7/4.41	94/112 3.7/4.41	96/125 3.78/4.92	96/125 3.78/4.92
Capacity	l cu in	1.55 94.6	2.33 142.2	3.62 220.9	3.62 220.9
Compression ratio		19:1	19:1	19:1	18:1
Nominal speeds	min ⁻¹ rpm	2300 - 2800	2300 - 2800	2300 - 2600	2300 - 2600

Power output ¹⁾		D 2011 L2 I	D 2011 L3 I	D 2011 L4 I	TD 2011 L4 I
Power output as per ISO 14396	kW hp	23 31	36.4 49	47.5 64	57.6 77.2
at speed	min ⁻¹ rpm	2800	2800	2600	2600
Max. torque	Nm lb/ft	90 66.4	137 101	190 140.1	240 177
at speed	min ⁻¹ rpm	1700	1700	1700	1600
Minimum idling speed	min ⁻¹ rpm	900	900	900	900
Specific fuel consumption ²⁾	g/kWh lb/hph	227 0.373	225 0.370	226 0.372	233 0.383
Weight as per DIN 70020 Part 7A ³⁾	kg lb	175 386	217 478	270 595	270 595

1) Capacity data on flywheel net.

2) Best full load consumption refers to diesel with a density of 0.835 kg/dm³ at 15°C | 6.96 lb/US gallon at 60°F.

3) Without starter/dynamo, cooler and fluids but with flywheel and flywheel housing.

The data on this data sheet are for information purposes only and are not binding values. The data in the quotation is definitive.

Torque curve

D 2011 L2 I - 23 kW|31 hp

D 2011 L3 I - 36.4 kW|49 hp

(T)D 2011 L4 I - (57.6 kW|77.2 hp)
47.5 kW|64 hp

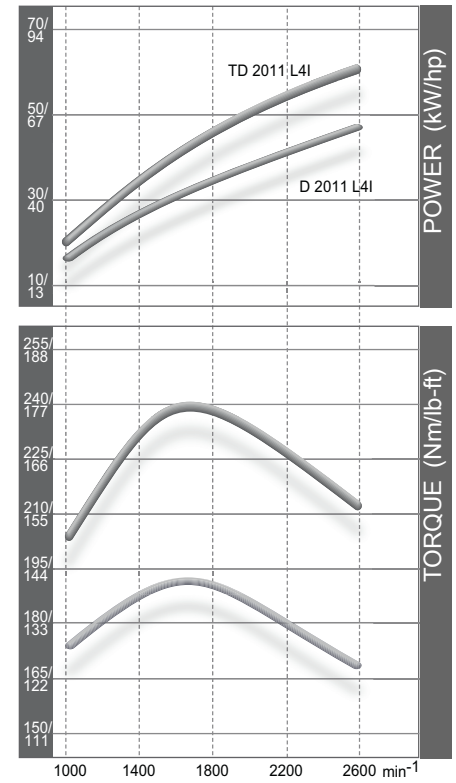
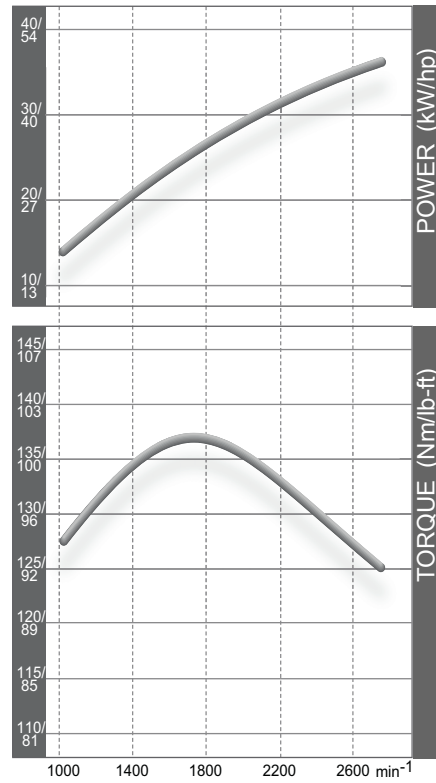
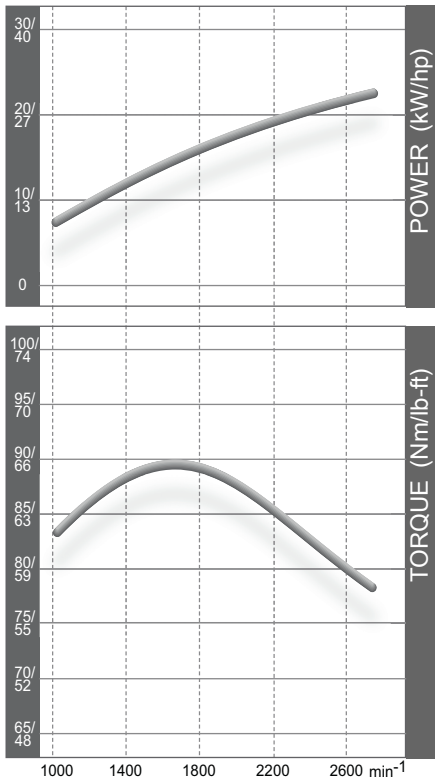

Dimensions

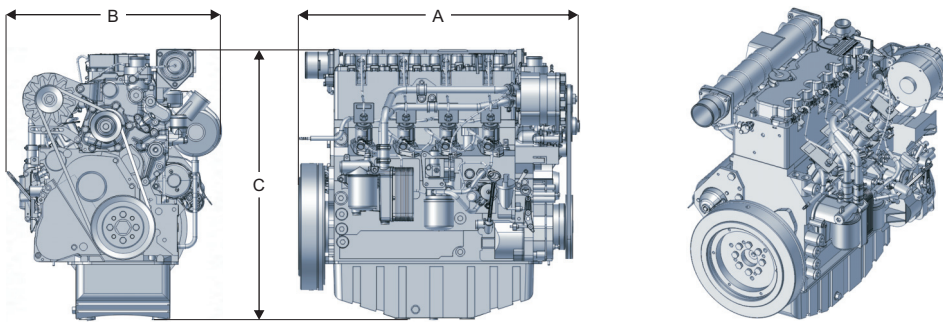

		A	B	C
air/oil-cooled with integrated cooling system				
D 2011 L2 I	mm in	573 22.56	448 17.64	673 26.5
D 2011 L3 I	mm in	612 24.09	448 17.64	673 26.5
D 2011 L4 I	mm in	732 28.82	448 17.64	713 28.07
TD 2011 L4 I	mm in	722 28.42	545 21.46	724 28.5
oil-cooled externally				
D 2011 L2	mm in	478 18.82	448 17.64	673 26.5
D 2011 L3	mm in	598 23.54	448 17.64	673 26.5
water-cooled externally				
D 2011 L4 W	mm in	720 28.35	486 19.13	711 27.99
TD 2011 L4 W	mm in	720 28.35	521 20.51	711 27.99
TCD 2011 L4 W	mm in	720 28.35	533 20.98	711 27.99

Note: The engine dimensions and weights vary depending on the scope of delivery.

Technical data oil-cooled externally

Engine type		D 2011 L2	D 2011 L3
No. of cylinders		2	3
Bore/stroke	mm in	94/112 3.7/4.41	94/112 3.7/4.41
Capacity	l cu in	1.55 94.6	2.33 142.2
Compression ratio		19:1	19:1
Nominal speeds	min ⁻¹ rpm	2300 - 2800	2300 - 2800

Power output ¹⁾		D 2011 L2	D 2011 L3
Power output as per ISO 14396	kW hp	23.5 31.5	36.5 49
at speed	min ⁻¹ rpm	2800	2800
Max. torque	Nm lb-ft	93 68.6	140 103.3
at speed	min ⁻¹ rpm	1700	1700
Minimum idling speed	min ⁻¹ rpm	900	900
Specific fuel consumption ²⁾	g/kWh lb/hph	230 0.378	230 0.378
Weight as per DIN 70020 Part 7A ³⁾	kg lb	169 373	210 463

1) Capacity data without deduction of fan capacity

2) Best full load consumption refers to diesel with a density of 0.835 kg/dm³ at 15°C | 6.96 lb/US gallon at 60°F.

3) Without starter/dynamo, cooler and fluids but with flywheel and flywheel housing.

The data on this data sheet are for information purposes only and are not binding values. The data in the quotation is definitive.

Torque curve

D 2011 L2 - 23.5 kW|31.5 hp

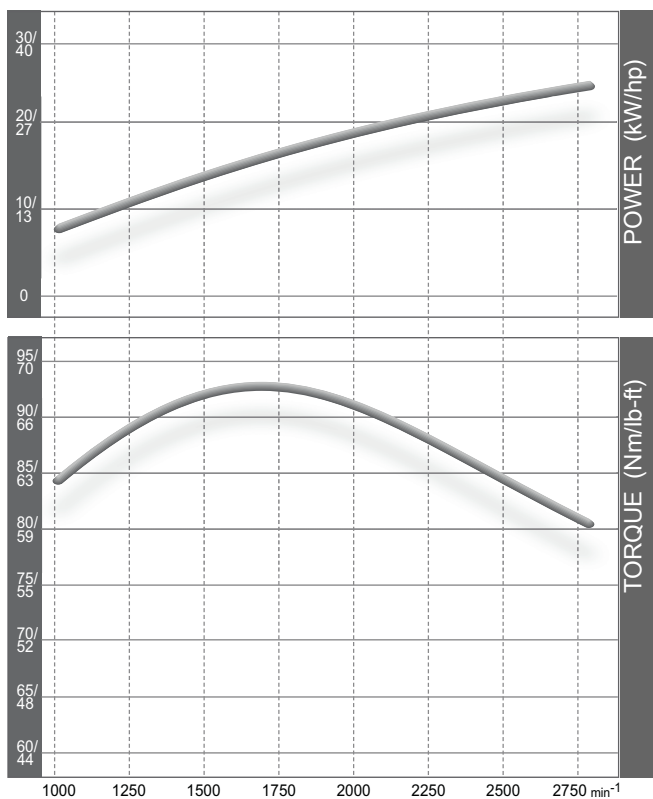

D 2011 L3 - 36.5 kW|49 hp

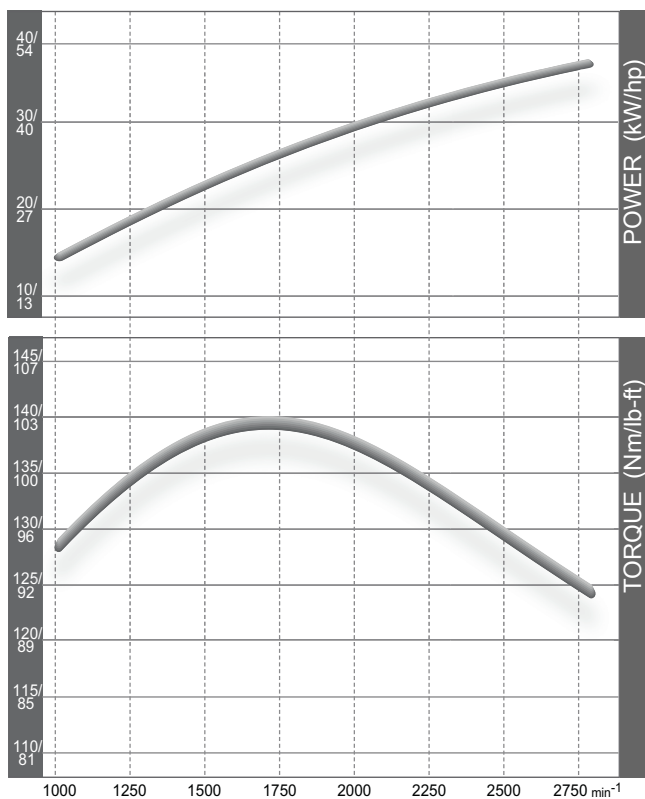

Technical data water-cooled externally

Engine type		D 2011 L4 W	TD 2011 L4 W	TCD 2011 L4 W
No. of cylinders		4	4	4
Bore/stroke	mm in	96/125 3.78/4.92	96/125 3.78/4.92	96/125 3.78/4.92
Capacity	l cu in	3.62 220.9	3.62 220.9	3.62 220.9
Compression ratio		19:1	18:1	18:1
Nominal speeds	min ⁻¹ rpm	2200 - 2600	2200 - 2600	2300 - 2600

Power output ¹⁾		D 2011 L4 W	TD 2011 L4 W	TCD 2011 L4 W
Power output as per ISO 14396	kW hp	50 67	68 91	74.9 100
at speed	min ⁻¹ rpm	2600	2600	2600
Max. torque	Nm lb/ft	210 154.9	280 206.5	350 258.2
at speed	min ⁻¹ rpm	1700	1600	1600
Minimum idling speed	min ⁻¹ rpm	900	900	900
Specific fuel consumption ²⁾	g/kWh lb/hph	218 0.358	223 0.367	216 0.355
Weight as per DIN 70020 Part 7A ³⁾	kg lb	270 595	269 593	269 593

1) Capacity data without deduction of fan capacity

2) Best full load consumption refers to diesel with a density of 0.835 kg/dm³ at 15°C | 6.96 lb/US gallon at 60°F.

3) Without starter/dynamo, cooler and fluids but with flywheel and flywheel housing.

The data on this data sheet are for information purposes only and are not binding values. The data in the quotation is definitive.

Torque curve

D 2011 L4 W - 50 kW|67 hp

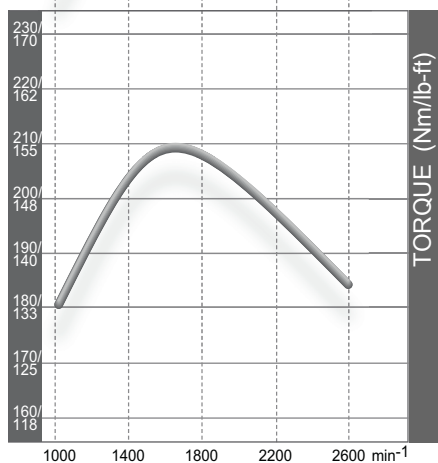
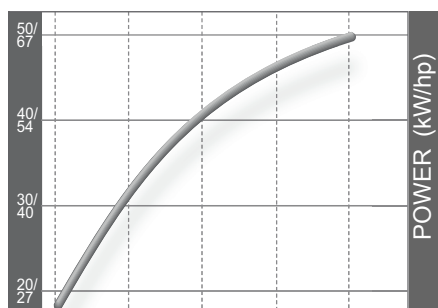

TD 2011 L4 W - 68 kW|91 hp

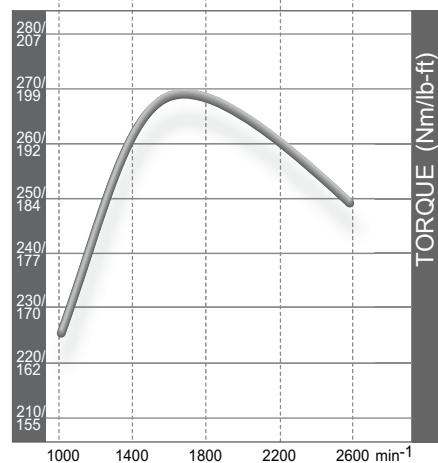
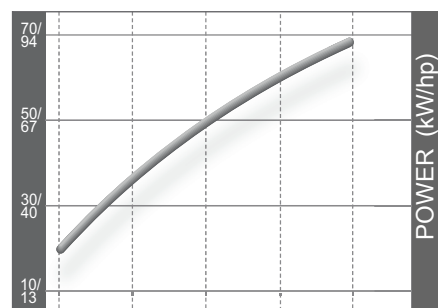

TCD 2011 L4W - 74.9 kW|100 hp

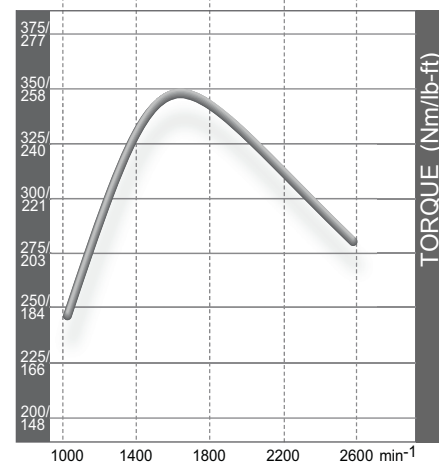
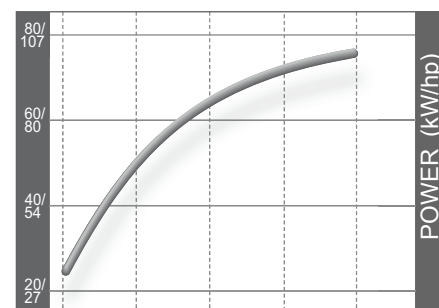

Order No. 0031 2163 / 09 / 2011 / VC-CM

For more information please contact the DEUTZ AG Köln or the responsible sales partner.

